



Submerged Arc Welding

Wire Wizard is a range of products to dispense welding wire from any kind of spool or drum to any kind of wire feeder. This means that whatever kind of drums you're using; Wire Wizard has a cone especially for your type of drum. And also that whatever brand of robot or manual welding machine you use; Wire Wizard has a connector specially for your type of wire feeder. In combination with the high quality conduit you are able to connect everything to anything.



With a simple combination of products it is possible to equip every robot or welding machine with a drum placed at a variable distance. Extra advantage is that every connection is

made with quick disconnections. This makes it very easy to replace or clean the conduit. To change from one type of wire to another can be done very fast.

Especially for the large wire diameters, Wire Wizard developed a range of Heavy Duty products.

The first goal of Wire Wizard is to improve the productivity of your welding cell. Our motto: "Give us your worst performing welding cell and we'll make it your best performing welding cell."

Spiral Conduits

	Article	Dimensions	Connector	Wire	Order	Coil
	FC-XH	7,5 x 15,50 mm	A-10R	1,6 - 2,4 mm	Per mtr	30,5 mtr
	FC-XH-LW	10,0 x 19,00 mm	A-9+A6 or A9 + A6 HD	2,4 - 4,8 mm	Per mtr	30,5 mtr
Polymer Conduits						
	EC-5	10,0 x 15,20 mm	A-10R	1,6 - 4,8 mm	Per mtr	152 mtr

HD Connector with large bayonet

Specially for the large wire diameters used in Submerged Arc Welding Wire Wizard developed a range of connectors with a large Bayonet. These HD connectors provide a larger feedthrough than the regular connectors and avoid the connector passage becomes a bottleneck in your system.

By using these heavy duty connectors wire shaving inside the connector can be avoid.

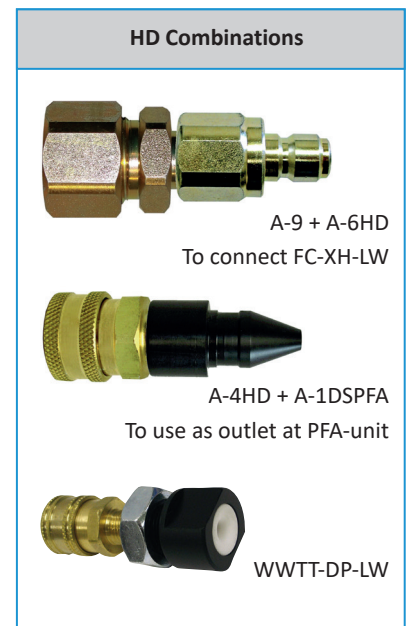
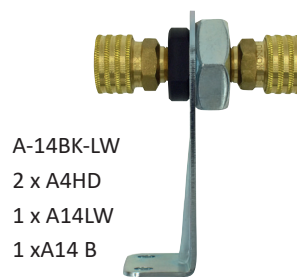
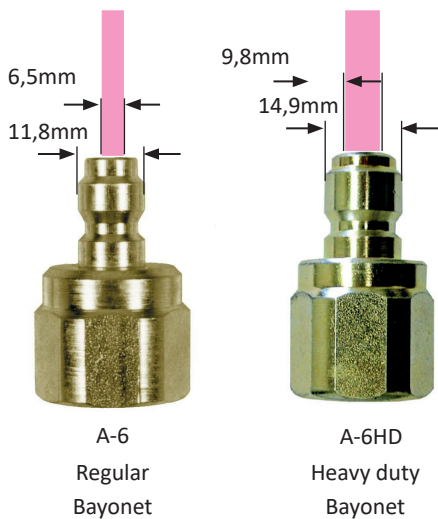

A-6HD
1/2" NPS



A-16M-ST-HD
3/8" NPT



A-5HD
1/2" NPS



A-4HD
3/8" NPT



A-3HD
3/8" NPS

PFA-Unit for SAW

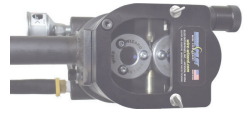
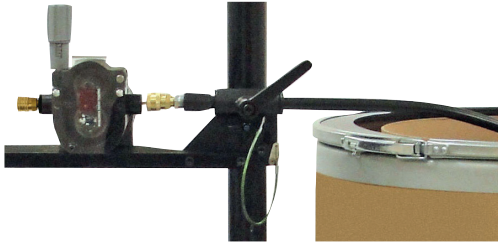

PFA3LW



PFA-FRL

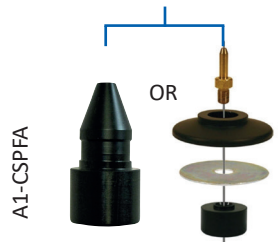

A1-CSPFA

PFA-DA-HD

Turn table Drum cone



PFA-oil



1 mt hose

Drive Rolls

PFA feed rollers U-Groove	Part No.
U-Groove Feed roll 2,0mm p.p.	PFADR20
U-Groove Feed roll 2,4mm p.p.	PFADR24
U-Groove Feed roll 3,2mm p.p.	PFADR32
U-Groove Feed roll 4,0mm p.p.	PFADR40



All items included in standard set except the Drive Rolls

Mechanical turn tables

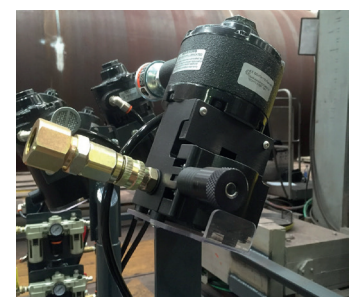

With single PFA for 2,0 to 2,8 mm

WWT-500
WWT-500 W + Wheels

Length x Width =
76x66cm
Weight: 64,5 kg
Max. Load : 500 Kg
Max Dia 66 cm

Removable guide arm
for easy drum change



Bracket for mounting
PFA-unit at Turn Table
Part # WWT-PBS

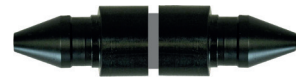
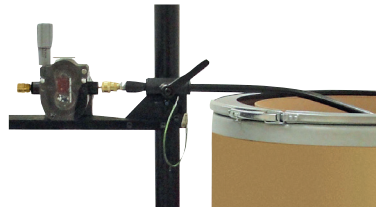

PFA-union connector A1DS-PFA-U
With double PFA for 3,2 to 5,0 mm

Wire Guide Modules for large wire

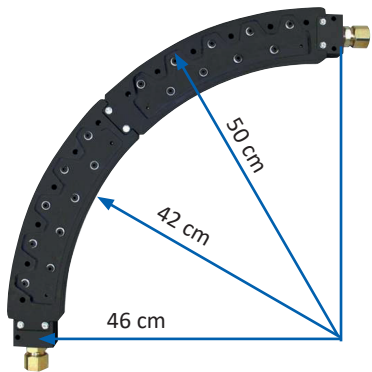

LW-Modules in use

- 2 x WGM-LW-1
- 1 X WGM-LW-ECK50
- 2 x A-9
- FC-XH-LW Conduit

- Up to 5,0mm wire
- Steel ball-bearing rollers
- Eliminate friction in bends
- Eliminate slipping feed motor
- Easy connected with conduit

Modules can be used in combination with PFA-unit

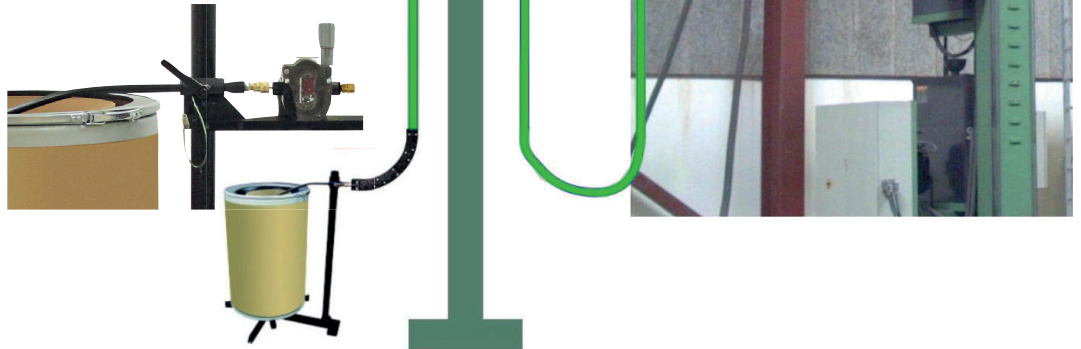





Flex module cable chain

Featuring the same innovative concept as the fixed radius Wire Wizard® Guide Modules, the Guide Module® FLEX System is designed especially for welding applications using a traversing axis, gantry or boom. The FLEX utilizes a series of rollers with bearings to eliminate skid friction on the wire, providing a smooth, consistent wire feed. Externally mountable to select igus® Track Systems. Large FLEX Modules are compatible with steel wire 1,6 mm to 4 mm, making them an ideal solution for SAW welding applications. End caps (sold separately) are 12,7 mm NPT-F threaded to fit Large Guide Module Fittings. Patent pending design.

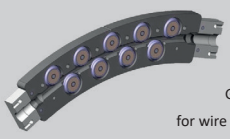

Description	Part No.
Wire Guide FLEX Module LW per Meter	WGM-F-LW-B
Wire Guide FLEX Module LW End Cap Kit	WGM-F-LW-ECK

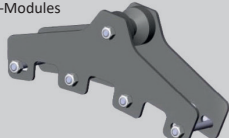
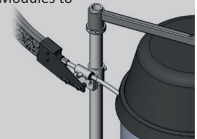
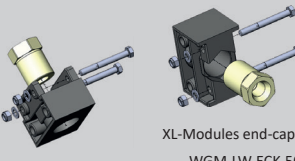
Wire Guide Modules accessoires

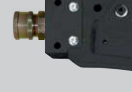
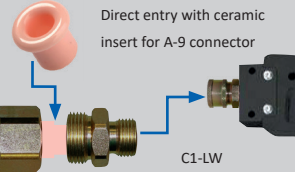
 <p>Large Wire Guide Module for wire up to 5,0 mm WGM-LW-1</p>	<p>Conduit connector for FC-XH-LW Part no. A-9</p>   <p>1/2" BSP Thread</p>	<p>Hanger/support bracket for XL-Modules</p> 	<p>Part no. WGM-4-BRKT Bracket to mount XL-Modules to the Turn Table</p> 
 <p>XL-Modules end-caps WGM-LW-ECK-50</p>	<p>Quick disconnect for Bayonet</p>   <p>1/2" BSP Thread</p>	<p>Direct entry with ceramic insert for A-9 connector</p>  <p>C1-LW</p>	<p>Conduit clamp for mounting FC-XH-LW to the boom EC6-CC</p> 